

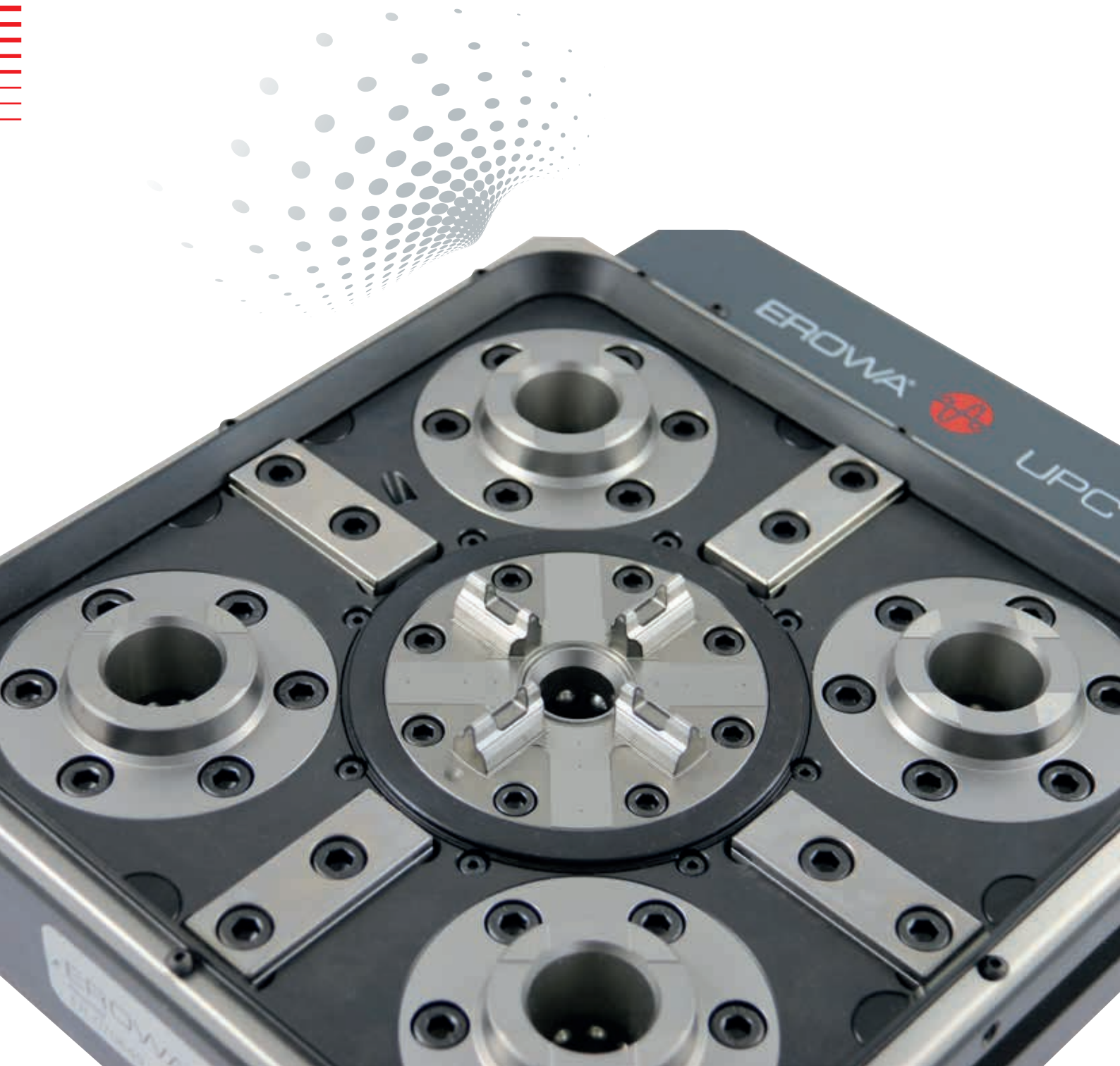

EROWA UPC

Universal, powerful, micron-accurate



EROWA UPC transcends the usual boundaries

The clamping system is characterized by high stability and reliability, even with workpieces measuring up to 500 x 500 x 500 mm. With a repeatability of 2 μm , the UPC leaves no wish unfulfilled also in terms of precision. A decisive factor for ITS users: The central ITS chuck guarantees seamless integration of existing holders and pallets.

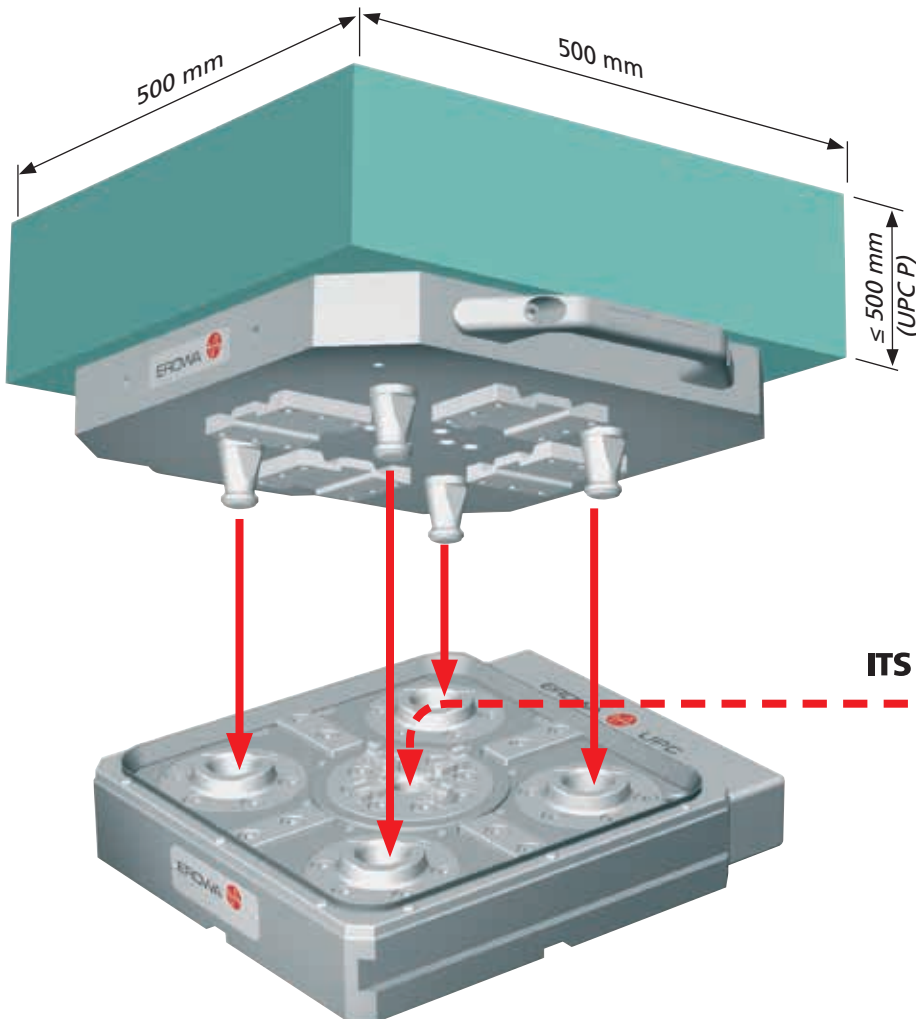

Flexible combination options:
Even conventional ITS pallets and holders fit directly into the UPC with the central ITS chuck.

ITS The  Original.

- Air-cleaned Z support surfaces.
- Cost-effective centering segments to build customized pallets.
- 4 x 90° indexable pallets.
- Stable centering segments with patented initial tension.
- Integrable ITS chuck in the center (optional).
- Four fixed mounted clamping spigots that are used also as supports in the pallet storage.
- Cost-effective aluminum pallets with hardened-Z-supports as a basis for any set-ups.

Applications



Handling

Manual / loader / robot

Function

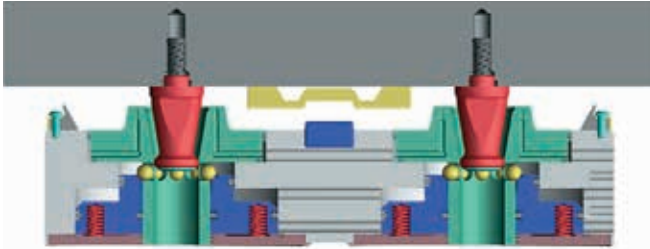

UPC chuck open

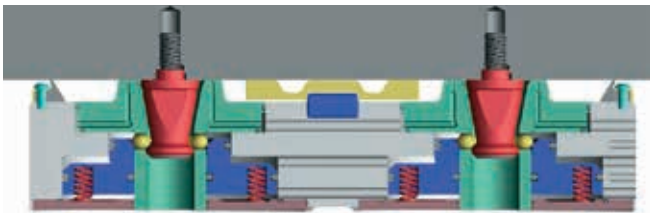

UPC chuck closed

The functional elements have a very simple design.

The lock generates a clamping power up to 50.000 N. The big distance between the supports creates an extreme degree of platform stability.

The pallet is pre-centered with chucking spigots. Then four robust centering segments take over to ensure precise positioning in the pallet und chuck. Compressed air is used for opening and cleaning.

Technical data – UPC

	UPC	UPC P "Production"
Pallet size	320 x 320 mm	320 x 320 mm
Chuck dimensions	280 x 280 mm	320 x 300 mm
System height (chuck and pallet)	104.5 mm (64.5 + 40 mm)	104.5 mm (64.5 + 40 mm)
Recommended workpiece sizes	up to 500 x 500 x 350 mm	up to 500 x 500 x 500 mm
Repeatability	0.002 mm	0.002 mm
Indexing, pallet positioned	4 x 90°	4 x 90°
Operation	clamped without pressure	clamped without pressure
Air connection (dry compressed air)	min. 6 bar	min. 6 bar
Operation	manual or automatic control unit	
Monitoring	pneumatic, electropneumatic evaluation	
Clamping power	32,000 N	50,000 N

THE FACTS

- Reliable
- Insensitive to dirt
- Robust
- Designed for continuous operation

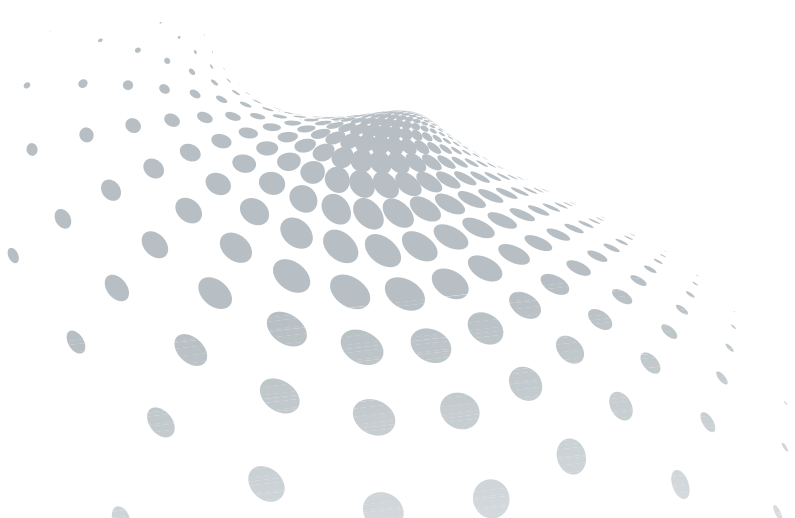

Nothing can shake it

The UPC clamping system is suitable for flexible use. Whether large electrodes on the quill of EDM machines or large workpieces in milling machines – UPC has been designed to cope with them, and it does.

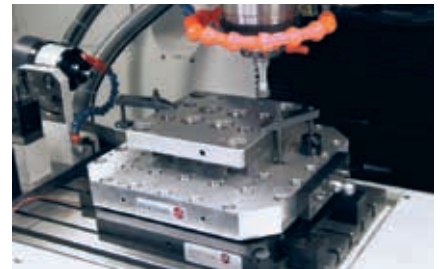
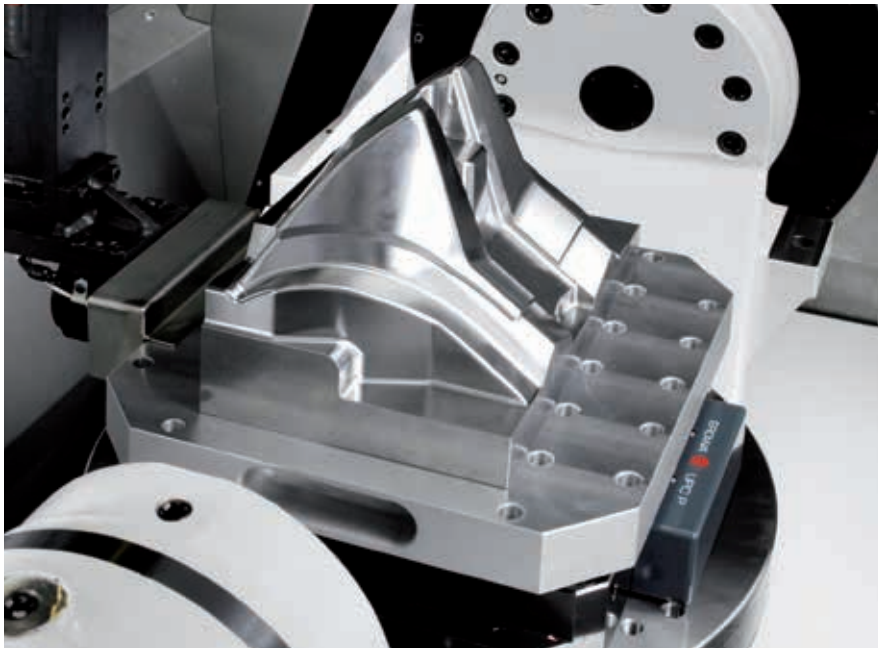

Customized solutions including. We'll be happy to advise you!



Low construction height leaves much room for workpieces.



There are matching PreSet stations for setting up and presetting. Manually or CNC-controlled.

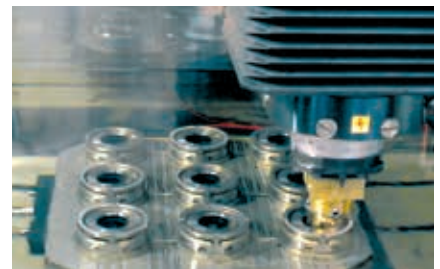

Convenient! Eroding on the UPC magnetic pallet.



On a clamping surface of up to 500 x 500 mm, also large workpieces can be easily mounted on the UPC pallet.



Powerful in heavy machining.

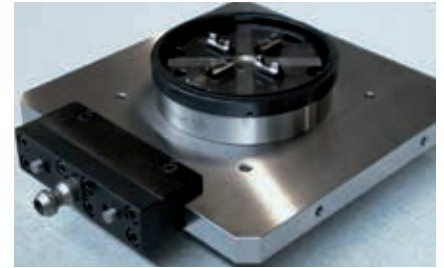

2 in 1: UPC adapter pallet with EROWA PowerChuck P.



UPC pallet with CleverClamp workpiece clamping system. Simply clamp different workpieces with different clamping elements on a pallet. The pallets can be automated.



UPC grid pallets: Ready for holding workpieces or fixtures.



Short set-up times with flexible clamping devices: EROWA ClampSet vises on UPC grid pallet.



The UPC chuck on the machine table is the interface to the workpiece carrier. Changeover takes just a few steps and then production can continue.



The UPC palletizing system is consistently automatable.



The chucks are completely sealed against ingress of coolant and chips. The contact surfaces are cleaned automatically and thoroughly with air.

The components

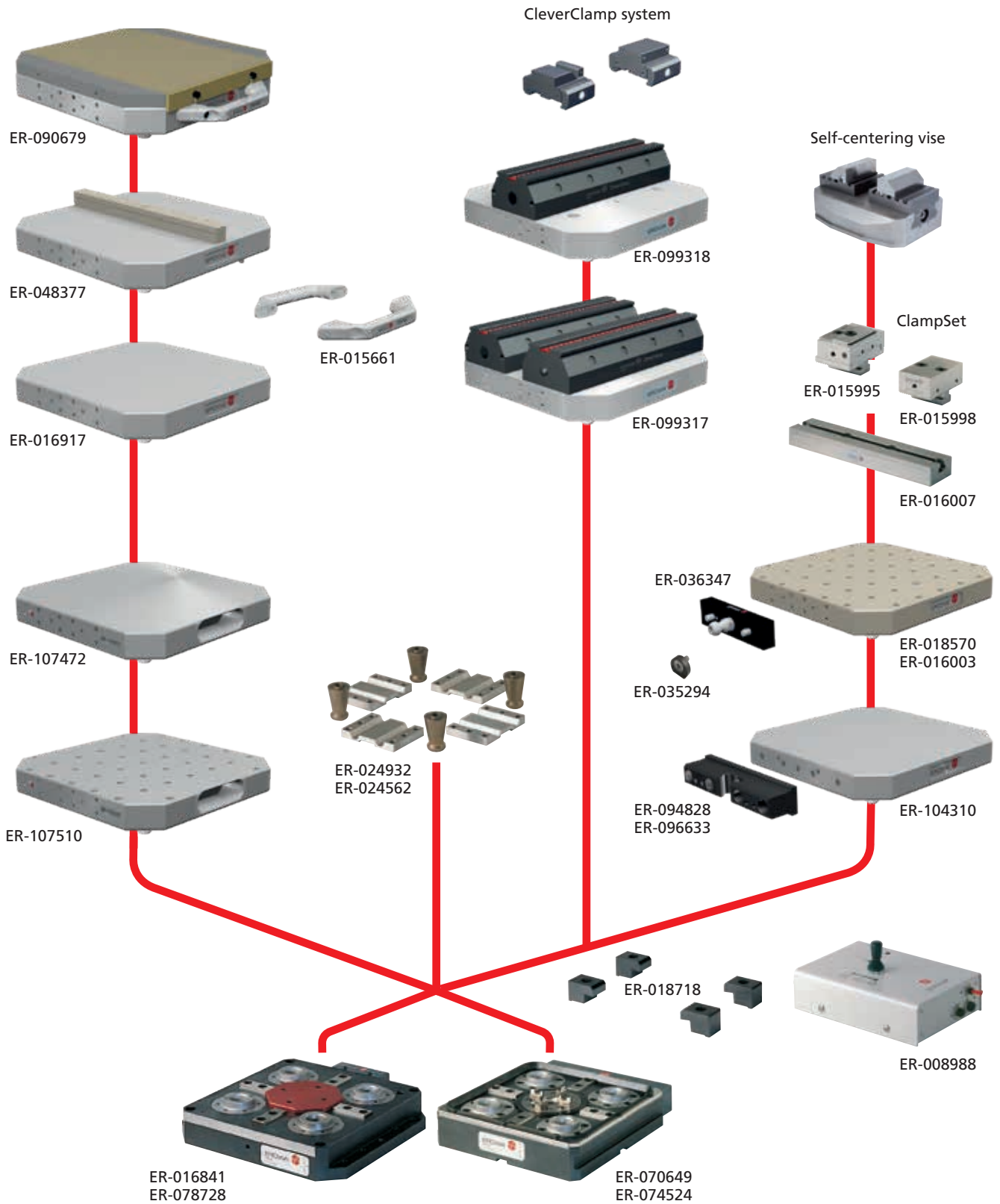

To make it easier for you to find your way about the fields of application for EROWA products, we use the following symbols in all our documents:



1. Manual operation



2. Operate with compressed air jet



3. Operate with manual valve



4. Operate with manual control unit



5. Operate with electro-pneumatic control unit



6. With central flushing clearance



7. Suited for submerged operation



8. Corrosion-resistant material



9. Suited for automatic operation



10. Handling with EROWA Robot gripper S



11. Handling with EROWA Robot gripper Combi



12. Handling with EROWA Robot gripper C



13. Handling with EROWA Robot gripper 72



14. Handling with EROWA Robot gripper 115



15. Handling with EROWA Robot gripper 148



16. Handling with EROWA Robot gripper RN PC 210



17. Handling with EROWA Robot gripper RCS



18. Handling with EROWA Robot gripper WGS-500



EROWA UPC PALLETIZING SYSTEM

UPC	Chucks	8
UPC	Pallets	9
UPC	Pallets CleverClamp system	11
UPC	Accessories	12



For cutting operations



For EDM



For wire-EDM

EROWA UPC Chuck

Technical specifications	UPC	UPC P "Production"	ITS Chuck 100 P	PowerChuck P
Repeatability	0.002 mm	0.002 mm	0.002 mm	0.002 mm
Indexing, pallet positioned	4 x 90°	4 x 90°	4 x 90°	4 x 90°
Clamping power of the chuck	32,000 N	50,000 N	6,000 N	10,000 N
Generated by	Spring tension	Spring tension	Spring tension	Spring tension
Opening (dry compressed air)	min. 6 bar	min. 6 bar	min. 6 bar	min. 6 bar

ER-074524 UPC chuck



Version UPC, prepared to accommodate an ITS chuck 100P.
 Connections Through the base and on the side.
 Application On milling, grinding, drilling and EDM sinking centers. In production lines.

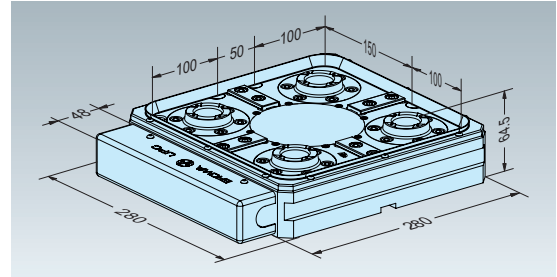

ER-070649 UPC chuck with ITS Chuck 100 P



Version UPC with ITS chuck 100P fitted and aligned.
 Connections Through the base and on the side.
 Application On milling, grinding, drilling and EDM sinking centers. In production lines.

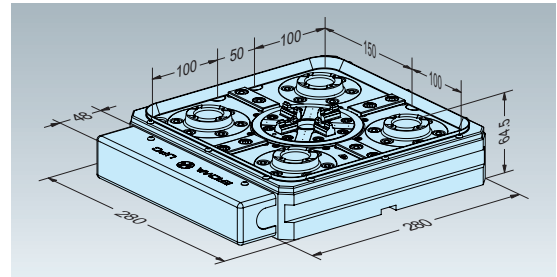

ER-016841 UPC P chuck



Version Chuck for high machining forces during chip removal.
 Connections Through the base and on the side.
 Application On milling, grinding, drilling and EDM centers and in production lines.
 Option UPC Sealing-Set ER-016650.

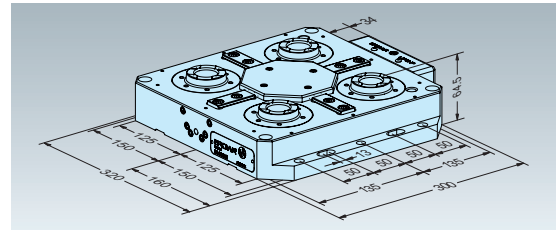

ER-078728 UPC P with connection on TK 57 mm with 2 air docks



Version Chuck for high machining forces during chip removal.
 Connections Through the base on pitch circle 57 mm and on the side.
 Application For milling, grinding, drilling and EDM centers and in production lines.
 Option UPC Sealing kit ER-016650 and ER-030580. Further system adaptations on request.

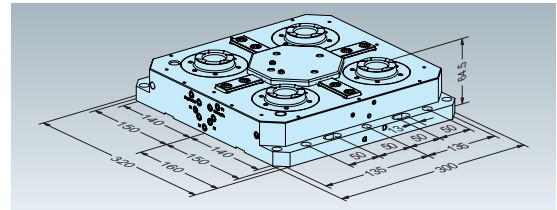

EROWA UPC Chuck

ER-030581 UPC P / PowerChuck P kit automatic composed of:



- Version: UPC P with air dock for the automatic operation of PowerChuck P.
- Content: 1 x ER-028784, UPC P with air duct and UPC seal kit
1 x ER-030580, PowerChuck P on UPC pallet with air duct
1 x Pneumatic tube.
- Requirements: *At least 4 air ducts available on the machine table.
*Air ducts for the PowerChuck P are only possible laterally.
If required, spacer plate can be used.
- Please note: Further system adaptations on request!

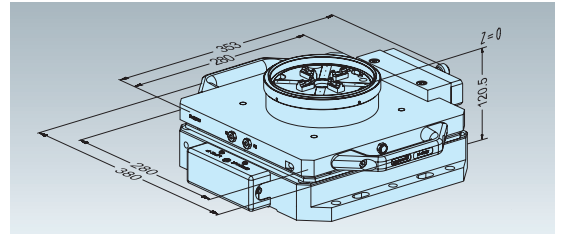

EROWA UPC Pallets

ER-016917 UPC pallet Alu 320 x 320 x 40 mounting surface grounded



- Version: Aluminum, centering segments and chucking spigots fitted, hard Z-support.
- Application: To clamp workpieces and gauges.
- Please note: Drill holes according to need.

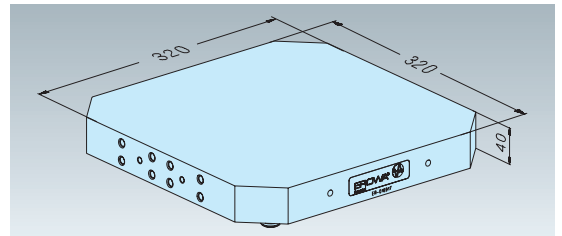

ER-104310 UPC pallet Alu 320 x 320 x 40 Mounting surface ground / WGS 40 mm



- Version: Aluminum, centering segments and chucking spigots fitted, hard Z-support. Prepared with bore pattern for WGS-500 40mm GripperLink.
- Application: To clamp workpieces and gauges.
- Please note: Drill holes according to need.

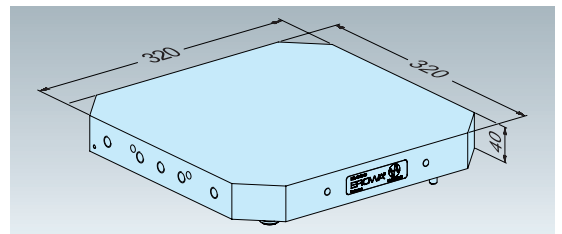

ER-018570 UPC pallet Alu R50 320 x 320 x 40 Mounting surface ground / anodized

ER-016003 UPC pallet Alu R50 320 x 320 x 40 Mounting surface ground



- Version: Aluminum with 50 mm grid. Centering segments and chucking spigots fitted. Hard Z-support.
- Application: Basis for gauges and workpieces.
- Info: Pattern borehole ø 12F7, M12 thread.

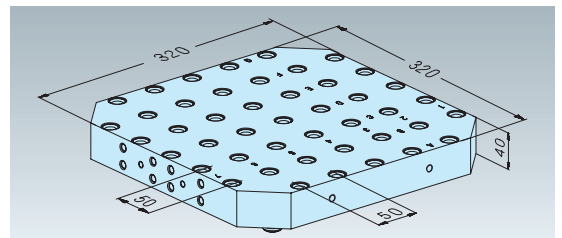

EROWA UPC

Pallets

ER-107472 UPC pallet Alu 320 x 320 x 40 mounting surface milled



Version Aluminum, centering segments and chucking spigots fitted, hard Z-support, integrated handles. Mounting surface milled.

Application To mount workpieces and gauges.

Mounting workpiece Drill holes according to need.

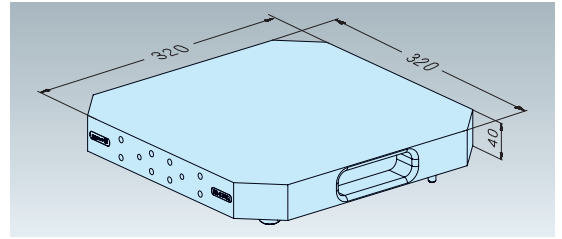

ER-107510 UPC pallet Alu R50 320 x 320 x 40 Mounting surface milled



Version Aluminum, centering segments and chucking spigots fitted, hard Z-support, integrated handles. Hole grid R50 for M10 nut inserts (option). Mounting surface milled.

Application To mount workpieces and gauges.

Option ER-032503 Insert nuts M10 (set of 12).

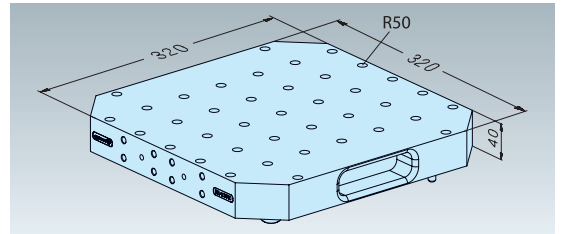

ER-090679 UPC magnet plate Neomicro 320 x 320 x 58 mm



Version Magnet plate assembled as a UPC pallet 320 x 320 x 58 mm.

Application To clamp workpieces for surface and profile grinding, EDM sinking, and high speed milling.

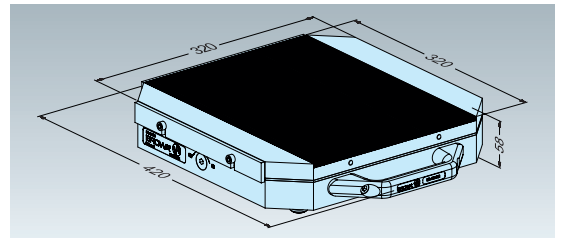

ER-048377 UPC alignment pallet 320 x 320 x 40 mm



Application To align angular position and to determine the center of UPC chucks.

Please note System parallelism 0.005 mm.
Borehole concentricity 0.005 mm.

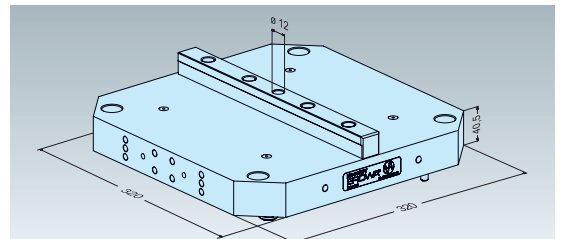

ER-029453 PowerChuck P on UPC pallet



Version Adapter pallet UPC - PowerChuck P.

Connections Laterally on pallet.

Application On machining centers. Operate with air-jet or fixed connection.

Note Manual load into UPC. Automatic load to PowerChuck P is possible. Further system adaptations on request.

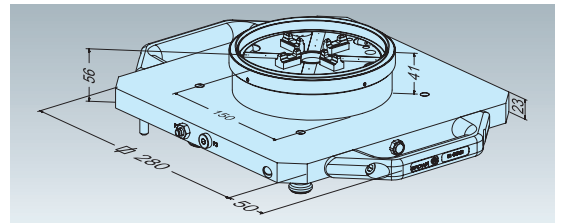

ER-030580 PowerChuck P on UPC pallet with air connection



Version Adapter pallet UPC - PowerChuck P.
 Connections From the bottom through of the pallet. Suitable for ER-028784 and ER-078728.
 Application On machining centers.
 Note Automatic load to UPC or PowerChuck is possible. Further system adaptations on request.

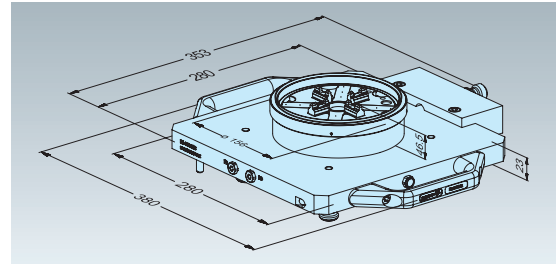

EROWA UPC Pallets CleverClamp System

ER-099318 Base UPC mono CleverClamp



Version Combination of UPC aluminum pallet with 320 rail; centering segments and chucking spigots fitted. Z-Support hard.
 Application Optimal accessibility for 5-axis applications with single and multiple fixtures.
 Accessories Order separately: GripperLink RCS / EWIS RAPID ER-036347 for Automation.

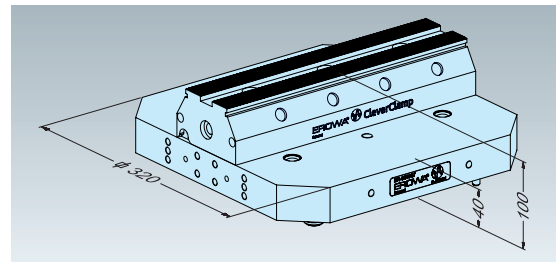

ER-099317 Base UPC duo CleverClamp



Version Combination of UPC aluminum pallet with two 320 rails; centering segments and chucking spigots fitted. Z-support hard.
 Application Optimal for multiple fixtures and for clamping big workpieces.
 Accessories Order separately: GripperLink RCS / EWIS RAPID ER-036347 for Automation.

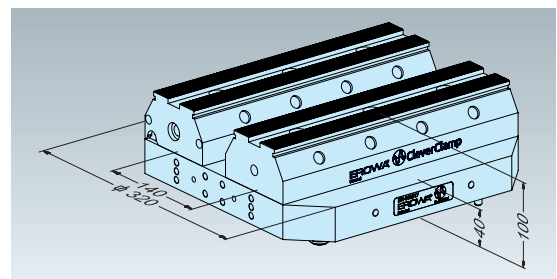

EROWA UPC

Accessories

ER-024932 UPC centering segments and chucking spigots, for mounting from above

Version Four segments and chucking spigots for UPC, including bolts.

Application To produce special UPC pallets.

Mounting With bolts through the pallet from above.

Note Easy to assemble on the UPC chuck.

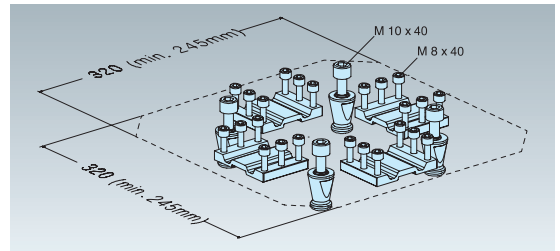
**ER-024562 UPC centering segments and spigots to mount from lower side**

Version Four segments and chucking spigots for UPC, including bolts.

Application To produce special UPC pallets.

Mounting With bolts through the pallet from below.

Note Easy to assemble on the PreSet Basic UPC presetting station.

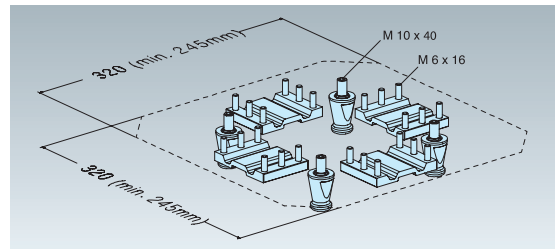
**ER-008988 Manual control unit**

Version Manual valve to control all the functions of ITS, ITS Compact CombiChuck, PowerChuck P and UPC: opening/reclamping/cleaning.

Application Operation of chucks on machines.

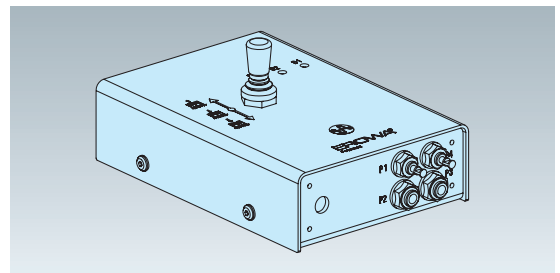
**ER-039466 Additional valve double**

Version For mounting to the manual control units ER-008988 and ER-073872, incl. set of hoses.

Application Operating of two separate chucks with one single control unit.

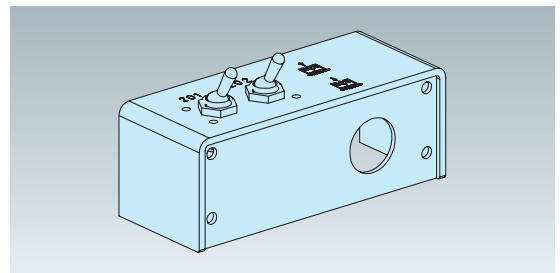
**ER-016531 UPC air jet connection**

Version Valve for the manual operation of UPC ER-016092, ER-016093, ER-074527 and ER-070649 with an air jet.

Application To be fitted on UPC cover.

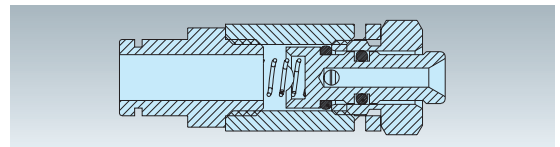

ER-018168 UPC P air jet connection



Version Valve for the manual operation of UPC P ER-016841 with an air jet.
 Application To be fitted on UPC P cover.

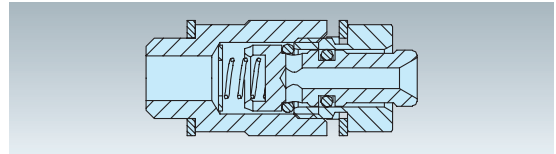

ER-012444 Cover for UPC



Version Aluminum.
 Application Cover for UPC.

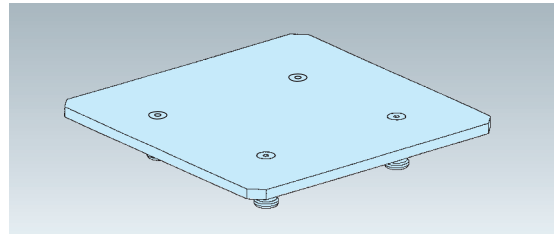

ER-094178 Cover set for UPC / ITS 50 C



Version Aluminum with inserts, to protect UPC chuck when used with holder ø72, pallet ø115, pallet ø148, electrode holders ITS 50 C.

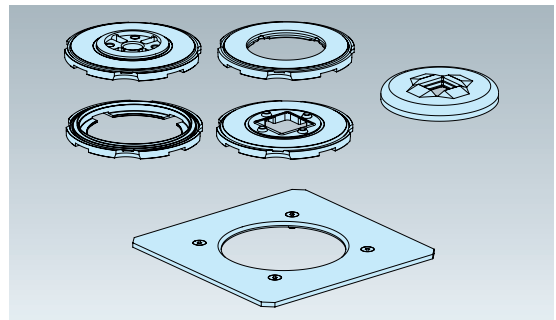

ER-018247 Cover UPC pallet ø 148



Version Aluminum. Cover for UPC ER-070649.
 Application Protects UPC system when ø 148 mm pallets are used in the ITS central chuck.

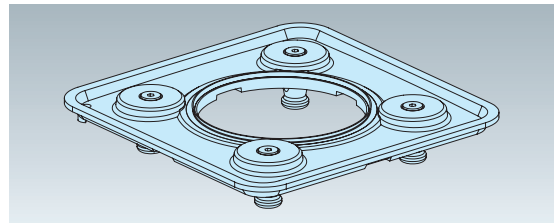

ER-016650 UPC sealing kit



Version Rubber seal and frame.
 Application To seal the UPC P against chips.
 Mounting With supplied bolts.
 Please note Fits UPC No. ER-016841/ER-070649/ER-074524/ER-078728.

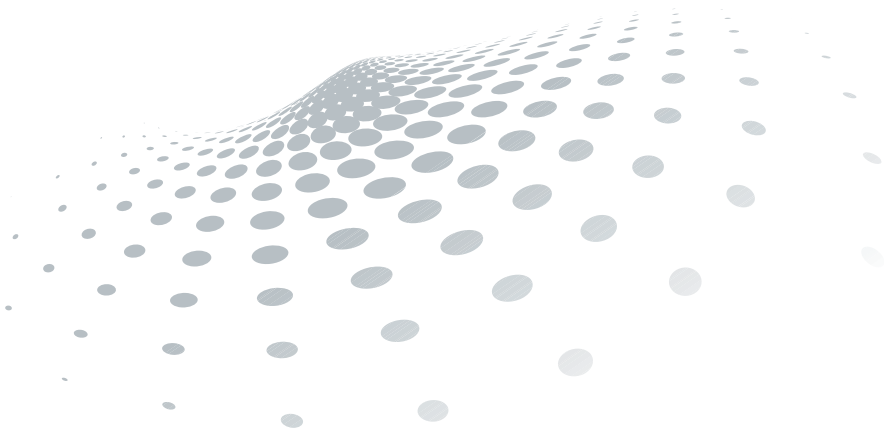
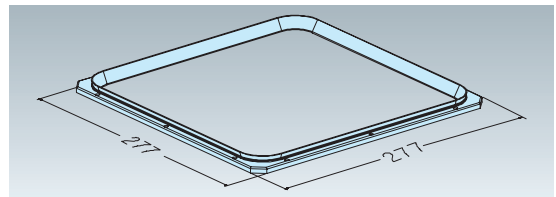

EROWA UPC

Accessories

ER-018718 UPC clamping bracket 4 pieces



Version High tension steel, mounting accessories not included.
 Application To mount UPC chucks to machine tables.
 Please note Fits UPC chuck No. ER-016841/ER-070649/ER-074524/
 ER-078728.

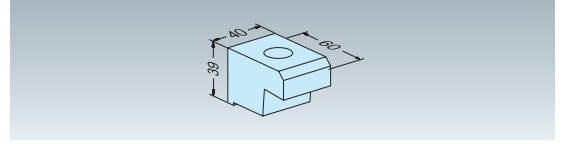

ER-015661 Handles for UPC pallets / FrameSet 2 pieces



Version Aluminum die-casting, set of 2 units.
 Application Safe handles for UPC pallets.
 Mounting With the enclosed bolts to the prepared threads.

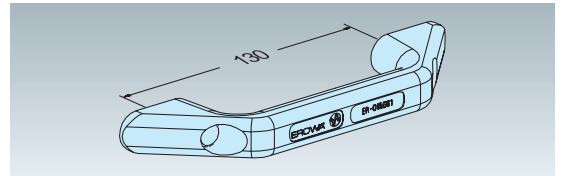

ER-018817 Sealing bolt M12x16 50 pieces



Version Set of 50, including square wrench.
 Application Plastic bolts to seal grid boreholes that are not in use.
 Suitable for ER-018570 and ER-016003.

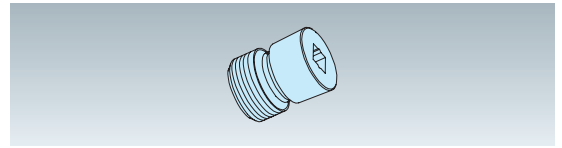

ER-036347 GripperLink RCS / EWIS™ Rapid



Version Coupling for UPC pallets, mounting accessories included.
 Application Suited for UPC pallets to be used on EROWA handling devices with the «RCS coupling system».

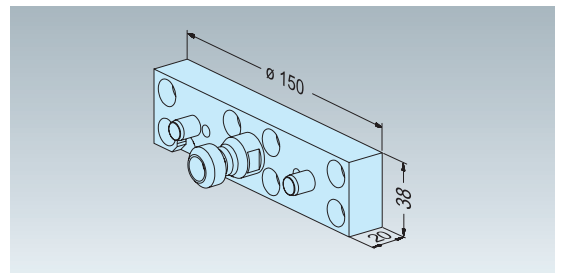

ER-094828 GripperLink WGS-500 40 mm without air connections



Version Coupling kit incl. screw set, for mounting on MTS or UPC pallets.
 Application For pallets on EROWA handling units that are equipped with the exchange gripper system „WGS-500”.

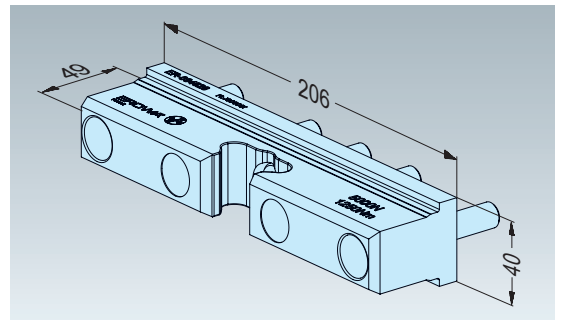

ER-096633 GripperLink WGS-500 40 mm with air connections



Version Coupling kit incl. screw set, for mounting on MTS or UPC pallets.
 Application For pallets on EROWA handling units that are equipped with the exchange gripper System „WGS-500“.
 Connections 4 AirDock valves, e.g. to control additional grippers.

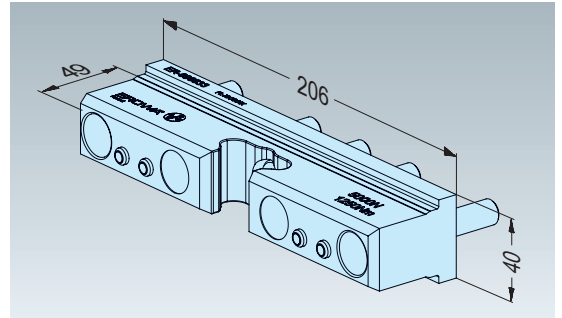

ER-035294 EWIS™ Rapid chip with chip holder RCS with chip ø 3 x 13.5mm



Version Holder with built-in data carrier. EWIS chip: read only.
 Application To build into RCS coupling, PalletSet W holder and Basic WEDM holder.

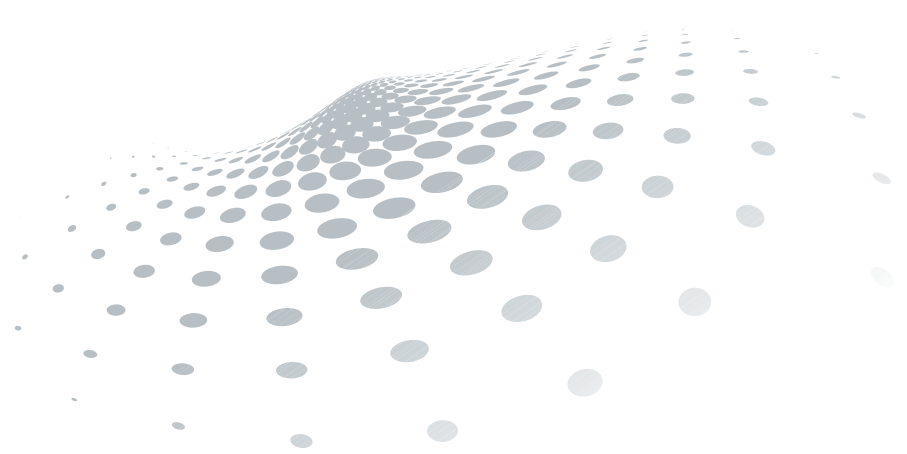
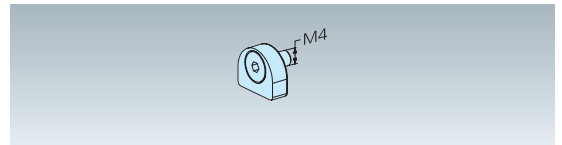

The next step

Important things need to be planned. And your next step is certainly among the important things. It is your start into a new, efficient era. We are pleased to be with you on the way. As consultants, in practice. For you to know at all times what you're engaging in. The next EROWA branch office is not far – **take the step.**



USA

EROWA Technology, Inc.
North American Headquarters
2535 South Clearbrook Drive
Arlington Heights, IL 60005
USA
Tel. 847 290 0295
Fax 847 290 0298
e-mail: info@erowa.com
www.erowa.com

Italy

EROWA Technologie S.r.l.
Sede Legale e Amministrativa:
Via Alfieri Maserati 48
IT-10095 Grugliasco (TO)
Italy
Tel. 011 9664873
Fax 011 9664875
info@erowa.it
www.erowa.com

Unità di Treviso:
Via Leonardo Da Vinci 8
IT-31020 Villorba (TV)
Italy
Tel. 0422 1627132

Singapore

EROWA South East Asia Pte. Ltd.
56 Kallang Pudding Road
#06-02, HH@Kallang
Singapore 349328
Singapore
Tel. 65 6547 4339
Fax 65 6547 4249
sales.singapore@erowa.com
www.erowa.com

Japan

EROWA Nippon Ltd.
Sibadaimon Sasano Bldg.
2-6-4, Sibadaimon, Minato-ku
105-0012 Tokyo
Japan
Tel. 03 3437 0331
Fax 03 3437 0353
info@erowa.co.jp
www.erowa.com

Switzerland

EROWA AG
Knutwilerstrasse 3
CH-6233 Büron
Switzerland
Tel. 041 935 11 11
Fax 041 935 12 13
info@erowa.com
www.erowa.com

France

EROWA Distribution France Sàrl
PAE Les Glaisins
12, rue du Bulloz
FR-74940 Annecy-le-Vieux
France
Tel. 4 50 64 03 96
Fax 4 50 64 03 49
erowa.france@erowa.com
www.erowa.com

Spain

EROWA Technology Ibérica S.L.
c/ Avda. Cornellà, 142 7ª 3ª ext.
E-08950 Esplugues de Llobregat - Barcelona
Spain
Tel. 093 265 51 77
Fax 093 244 03 14
erowa.iberica.info@erowa.com
www.erowa.com

China

EROWA Technology (Shanghai) Co., Ltd.
G/F, No. 24 Factory Building House
69 Gui Qing Road (Caohejing Hi-tech Park)
Shanghai 200233, PRC
China
Tel. 021 6485 5028
Fax 021 6485 0119
info@erowa.cn
www.erowa.com

Germany

EROWA System Technologien GmbH
Gewerbegebiet Schwadernmühle
Roßendorfer Straße 1
DE-90556 Cadolzburg/Nbg
Germany
Tel. 09103 7900-0
Fax 09103 7900-10
info@erowa.de
www.erowa.de

Scandinavia

EROWA Technology Scandinavia A/S
Fasanvej 2
DK-5863 Ferritslev Fyn
Denmark
Tel. 65 98 26 00
Fax 65 98 26 06
info.scandinavia@erowa.com
www.erowa.com

Eastern Europe

EROWA Technology Sp. z o.o.
Eastern Europe
ul. Spółdzielcza 37-39
55-080 Kąty Wrocławskie
Poland
Tel. 71 363 5650
Fax 71 363 4970
info@erowa.com.pl
www.erowa.com

India

EROWA Technology (India) Private Limited
No: 6-3-1191/6, Brij Tarang Building
Unit No-3F, 3rd Floor, Greenlands, Begumpet,
Hyderabad 500016 (Telangana)
India
Tel. 040 4013 3639
Fax 040 4013 3630
sales.india@erowa.com
www.erowa.com